



Rear View Mirrors — Interior

Special Tool(s)

 <p>ST1137-A</p>	<p>73III Automotive Meter 105-R0057 or equivalent</p>
 <p>ST2834-A</p>	<p>Vehicle Communication Module (VCM) and Integrated Diagnostic System (IDS) software with appropriate hardware, or equivalent scan tool</p>

Principles of Operation

Interior Auto-Dimming Rear View Mirror

NOTE: The Smart Junction Box (SJB) may also be identified as the Generic Electronic Module (GEM).

The interior auto-dimming rear view mirror feature automatically reduces the glare caused by headlamps reflecting in the interior rear view mirror. Voltage is supplied from the [SJB](#) to the interior auto-dimming mirror when the ignition is in the RUN position or the accessory delay is active. When the vehicle is in the REVERSE position, voltage is sent to the interior auto-dimming mirror from the [SJB](#) to disable the auto-dimming mirror feature.

The interior auto-dimming rear view mirror has 2 photoelectric sensors that detect forward and rearward light conditions. Based on these inputs, the automatic dimming feature adjusts the reflectance level of the interior rear view mirror glass to eliminate unwanted glare. The reflectance level of the mirror glass is variable and depends on the amount of rear glare in relation to ambient light conditions in front of the interior mirror.

When the forward sensor detects daytime conditions, the rearward sensor is inactive and the interior rear view mirror stays in a high reflectance mode. When the forward sensor detects nighttime conditions, the rearward sensor is active and detects glare from the headlights of vehicles approaching from the rear or other glare-producing light sources. To provide increased visibility when backing up, the interior rear view mirror will automatically return to a high reflectance mode whenever the vehicle is in REVERSE.

If the forward or rearward sensors are blocked, the interior auto-dimming rear view mirror might not work correctly.

Inspection and Verification

1. Verify the customer concern.
2. Visually inspect for obvious signs of mechanical or electrical damage.

Visual Inspection Chart

Mechanical	Electrical
<ul style="list-style-type: none"> • Interior rear view mirror 	<ul style="list-style-type: none"> • Smart Junction Box (SJB) fuse 7 (10A)

	<ul style="list-style-type: none"> • SJB • Interior auto-dimming rear view mirror • Loose or corroded connections • Wiring harness
--	--

- If an obvious cause for an observed or reported concern is found, correct the cause (if possible) before proceeding to the next step.
- NOTE:** Make sure to use the latest scan tool software release.

If the cause is not visually evident, connect the scan tool to the Data Link Connector (DLC).

- NOTE:** The Vehicle Communication Module (VCM) LED prove-out confirms power and ground from the [DLC](#) are provided to the [VCM](#).

If the scan tool does not communicate with the [VCM](#) :

- check the [VCM](#) connection to the vehicle.
- check the scan tool connection to the [VCM](#).
- refer to [Section 418-00](#), No Power To The Scan Tool, to diagnose no power to the scan tool.

- If the scan tool does not communicate with the vehicle:
 - verify the ignition key is in the ON position.
 - verify the scan tool operation with a known good vehicle.
 - refer to [Section 418-00](#) to diagnose no response from the [SJB](#).
- Carry out the network test.
 - If the scan tool responds with no communication from one or more modules, refer to [Section 418-00](#).
 - If the network test passes, retrieve and record the continuous memory DTCs.
- Clear the continuous DTCs and carry out the self-test diagnostics for the [SJB](#).
- If the DTCs retrieved are related to the concern, go to the Smart Junction Box (SJB) DTC Chart. For all other DTCs, refer to [Section 419-10](#).
- If no DTCs related to the concern are retrieved, GO to [Symptom Chart - Interior Mirror](#).

DTC Charts

Smart Junction Box (SJB) DTC Chart

DTC	Description	Action
B2567	Reverse Mirror Output Circuit Failure	GO to Pinpoint Test D .
B2568	Reverse Mirror Output Circuit Short to Ground	GO to Pinpoint Test D .
All other DTCs	—	Refer to Section 419-10 .

Symptom Chart — Interior Mirror

Symptom Chart — Interior Mirror

Condition	Possible Sources	Action
<ul style="list-style-type: none"> • The interior mirror vibrates/loose 	<ul style="list-style-type: none"> • Interior mirror mounting loose 	<ul style="list-style-type: none"> • REMOVE the interior mirror. REFER to Interior Rear View Mirror or Auto-Dimming Interior Mirror. INSPECT the

		interior mirror mount for damage. INSTALL the interior mirror, making sure that it is fully seated.
<ul style="list-style-type: none"> The interior mirror is blemished 	<ul style="list-style-type: none"> Interior mirror glass/housing is dirty 	<ul style="list-style-type: none"> NOTE: Do not clean the housing or glass of any mirror with harsh abrasives, fuel or other petroleum-based cleaning products. <p>CLEAN the affected interior mirror surface.</p>
<ul style="list-style-type: none"> The auto-dimming mirror does not operate correctly 	<ul style="list-style-type: none"> Obstructed rearward-facing sensor: <ul style="list-style-type: none"> stickers, window decals, tags non-OEM window tinting Obstructed forward-facing sensor: <ul style="list-style-type: none"> stickers, window decals, tags non-OEM window tinting Light source near or inside of vehicle Vehicle inside garage or tunnel Fuse Smart Junction Box (SJB) Interior auto-dimming mirror Circuitry 	<ul style="list-style-type: none"> If possible, REMOVE the obstruction. If the obstruction cannot be removed, GO to Pinpoint Test D to test the interior auto-dimming mirror for correct function. None. Any light source the rear-facing sensor is exposed to can be considered glare. None. Ambient light conditions are similar to nighttime. GO to Pinpoint Test D.
<ul style="list-style-type: none"> Interior mirror compass concerns 	<ul style="list-style-type: none"> — 	<ul style="list-style-type: none"> GO to Section 419-11.

Pinpoint Tests

Pinpoint Test D: The Auto-Dimming Mirror Does Not Operate Correctly

Refer to Wiring Diagrams Cell [124](#), Power Mirrors for schematic and connector information.

Normal Operation

Under normal operation, the interior auto-dimming-mirror receives voltage from Smart Junction Box (SJB) fuse 7 (10A) through circuit 46 (VT) and ground from circuit 1205 (BK). When the vehicle is placed in REVERSE, the [SJB](#) supplies voltage to circuit 2016 (WH/LG) and the interior auto-dimming mirror will turn the dimming feature off. There are 2 photoelectric sensors: one in the front of the interior rear view mirror and one mounted on the glass side of the mirror. If the sensors are blocked, the auto-dimming feature might not work correctly. Always verify both sensors are not physically blocked before attempting to diagnose auto-dimming mirror concerns.

- DTC B2567 Reverse Mirror Output Circuit Failure — Open or short to voltage on interior mirror reverse output circuit.
- DTC B2568 Reverse Mirror Output Circuit Short to Ground — Short to ground on interior mirror reverse output circuit.

This pinpoint test is intended to diagnose the following:

- Fuse
- [SJB](#)
- Wiring, terminals or connectors
- Interior auto-dimming mirror

PINPOINT TEST D: THE AUTO-DIMMING MIRROR DOES NOT OPERATE CORRECTLY

NOTE: If the Transmission Range (TR) sensor is malfunctioning and the backup lamps are on all the time or do not turn on, the auto-dimming interior mirror will not darken or return to normal view.

Test Step	Result / Action to Take
D1 RETRIEVE THE DTCs FROM THE SJB <ul style="list-style-type: none"> • Use the recorded SJB DTCs from the continuous and on-demand self tests. • Are any DTCs retrieved? 	Yes If DTC B2567, GO to D10 . If DTC B2568, GO to D14 . No GO to D2 .
D2 CHECK OPERATION OF THE BACKUP LAMPS <ul style="list-style-type: none"> • Ignition ON. • Move the selector lever through the entire range. • Do the backup lamps illuminate only in REVERSE? 	Yes GO to D3 . No REFER to Section 417-01 to diagnose the backup lamps.
D3 VERIFY THE FORWARD AND REARWARD FACING SENSORS ARE NOT BLOCKED <ul style="list-style-type: none"> • Visually verify the forward and rearward facing sensors are not blocked. Sources of blockage can include: <ul style="list-style-type: none"> ▪ stickers, window decals or tags. ▪ fold-down screens for TVs or DVD players. ▪ non-OEM window tinting. • Were either of the sensors blocked? 	Yes If possible, REMOVE the blockage. TEST the system for normal operation. If it is not possible to remove the blockage, REVIEW the operation of the interior auto-dimming mirror with the customer. No GO to D4 .
D4 CHECK OPERATION OF THE INTERIOR AUTO-DIMMING MIRROR — DAYLIGHT CONDITIONS <ul style="list-style-type: none"> • Ignition ON. • Use a bright lamp to illuminate the forward facing sensor and the rearward facing sensor. The mirror should adjust to a high reflectance mode (mirror will be clear). 	Yes GO to D5 . No INSTALL a new interior auto-dimming mirror. REFER to Auto-Dimming Interior Mirror in this section. TEST the system for normal operation.

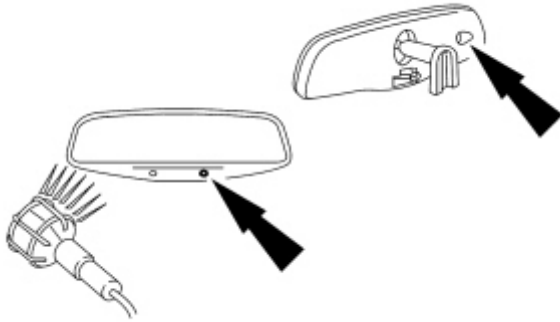

N0057545

- Does the mirror adjust to the high reflectance (clear) mode?

D5 CHECK OPERATION OF THE INTERIOR AUTO-DIMMING MIRROR — NIGHTTIME CONDITIONS WITHOUT GLARE

- Ignition ON.
- **NOTE:** Covering the sensor with a finger or hand is not adequate.
- Simulate nighttime conditions without glare:
 - cover the forward sensor with black electrical tape or other dark material.
 - cover the rearward facing sensor. The mirror should adjust to the high reflectance mode.

Yes
GO to [D6](#).

No
GO to [D8](#).

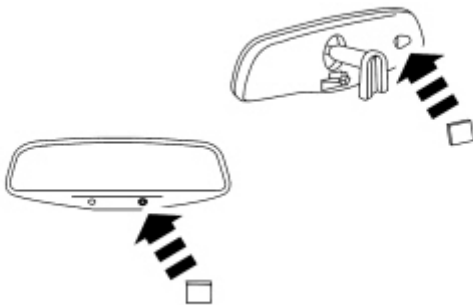

N0057547

- Did the mirror adjust to the high reflectance (clear) mode?

D6 CHECK OPERATION OF THE INTERIOR AUTO-DIMMING MIRROR — NIGHTTIME CONDITIONS WITH GLARE

- Ignition ON.
- **NOTE:** Covering the sensor with a finger or hand is not adequate.
- Simulate nighttime conditions with glare:
 - cover the forward sensor with black electrical tape or other dark material.
 - illuminate the rearward facing sensor. The mirror should darken to a lower reflectance mode.

Yes
GO to [D7](#).

No
GO to [D8](#).

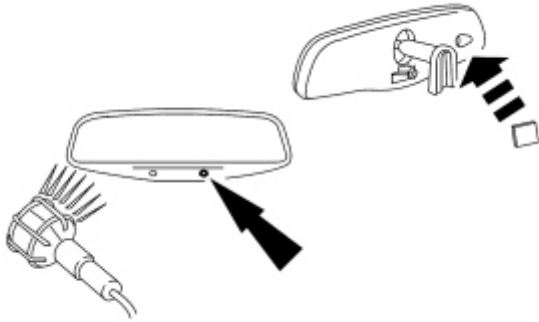

N0057546

- Did the mirror darken to a lower reflectance (darker) mode?

D7 CHECK OPERATION OF THE INTERIOR AUTO-DIMMING MIRROR — NIGHTTIME CONDITIONS WITH THE VEHICLE IN REVERSE

- Ignition ON.
- **NOTE:** Covering the sensor with a finger or hand is not adequate.
- Simulate nighttime conditions with glare:
 - cover the forward sensor with black electrical tape or other dark material.
 - illuminate the rearward facing sensor.

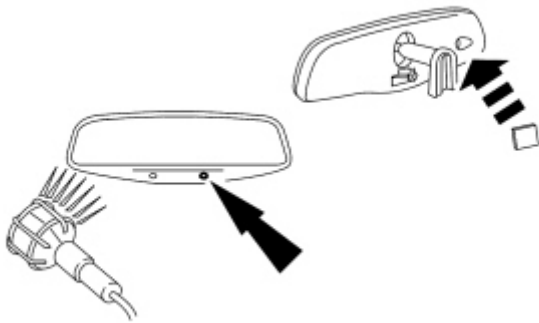

N0057546

- Select REVERSE.
- Did the mirror adjust to a high reflectance (clear) mode?

Yes

The system is operating normally at this time. REVIEW operation of the interior auto-dimming mirror feature with the customer.

No

GO to [D8](#).

D8 CHECK CIRCUIT 46 (VT) FOR VOLTAGE

- Ignition OFF.
- Disconnect: Interior Auto-Dimming Mirror C911.
- Ignition ON.
- Measure the voltage between interior auto-dimming mirror C911-1, circuit 46 (VT), harness side and ground.

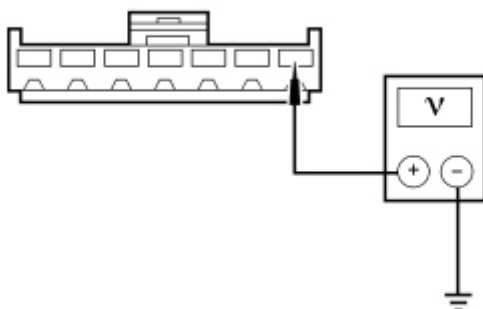

A0073174

Yes

GO to [D9](#).

No

VERIFY [SJB](#) fuse 7 (10A) is OK. If OK, REPAIR the circuit. If not OK, REFER to the Wiring Diagrams Manual to identify the possible causes of the circuit short. TEST the system for normal operation.

- Is the voltage greater than 10 volts?

D9 CHECK CIRCUIT 1205 (BK) FOR AN OPEN

- Ignition OFF.
- Measure the resistance between interior auto-dimming mirror C911-2, circuit 1205 (BK), harness side and ground.

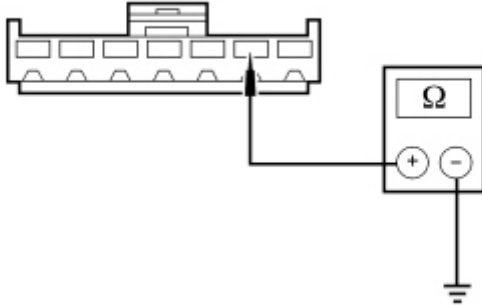

A0073175

- Is the resistance less than 5 ohms?

Yes

INSTALL a new interior auto-dimming mirror. REFER to [Auto-Dimming Interior Mirror](#) in this section. TEST the system for normal operation.

No

REPAIR the circuit. TEST the system for normal operation.

D10 CHECK CIRCUIT 2016 (WH/LG) FOR VOLTAGE

- Ignition OFF.
- Disconnect: Interior Auto-Dimming Mirror C911.
- Ignition ON.
- Select NEUTRAL.
- Measure the voltage between interior auto-dimming mirror C911-3, circuit 2016 (WH/LG), harness side and ground.

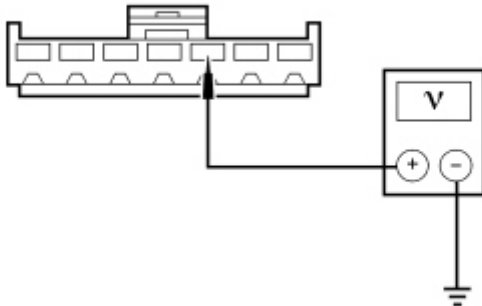

A0073178

- Is any voltage present?

Yes

GO to [D11](#).

No

GO to [D12](#).

D11 CHECK CIRCUIT 2016 (WH/LG) FOR A SHORT TO VOLTAGE

- Ignition OFF.
- Disconnect: [SJB](#) C2280C.
- Ignition ON.
- Measure the voltage between interior auto-dimming mirror C911-3, circuit 2016 (WH/LG), harness side and ground.

Yes

REPAIR the circuit. CLEAR the DTCs. REPEAT the self-test.

No

GO to [D16](#).

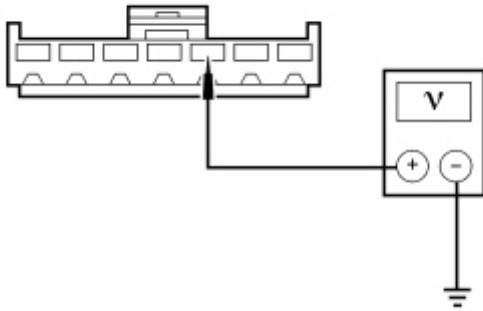

A0073178

- Is any voltage present?

D12 CHECK CIRCUIT 2016 (WH/LG) FOR VOLTAGE WITH VEHICLE IN REVERSE

- Ignition ON.
- Select REVERSE.
- Measure the voltage between interior auto-dimming mirror C911-3, circuit 2016 (WH/LG), harness side and ground.

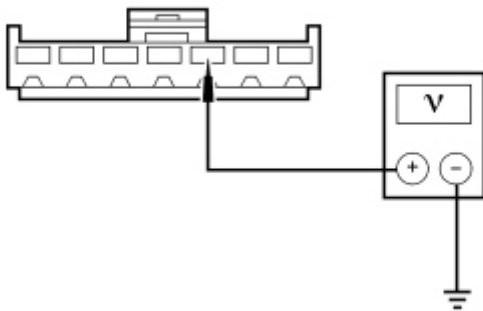

A0073178

- Is the voltage greater than 10 volts?

Yes
 INSTALL a new interior auto-dimming mirror. REFER to [Auto-Dimming Interior Mirror](#) in this section. CLEAR the DTCs. REPEAT the self-test.

No
 GO to [D13](#).

D13 CHECK CIRCUIT 2016 (WH/LG) FOR AN OPEN

- Ignition OFF.
- Disconnect: [SJB C2280C](#).
- Measure the resistance between auto-dimming interior mirror C911-3, circuit 2016 (WH/LG), harness side and [SJB C2280C-3](#), circuit 2016 (WH/LG), harness side.

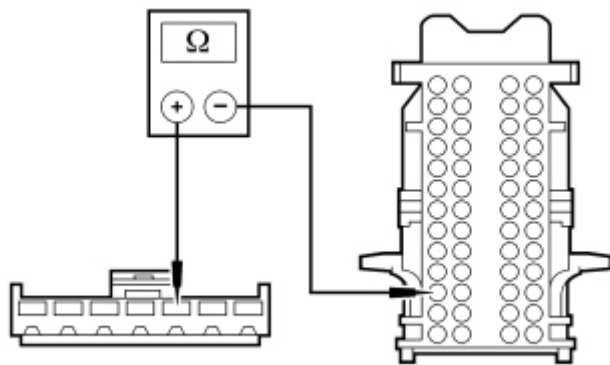

N0076772

- Is the resistance less than 5 ohms?

Yes
 GO to [D16](#).

No
 REPAIR the circuit. CLEAR the DTCs. REPEAT the self-test.

D14 CHECK THE REVERSE OUTPUT CIRCUIT FOR A SHORT TO GROUND

- Ignition OFF.

Yes

- Disconnect: Interior Auto-Dimming Mirror C911.
- Measure the resistance between interior auto-dimming mirror C911-3, circuit 2016 (WH/LG), harness side and ground.

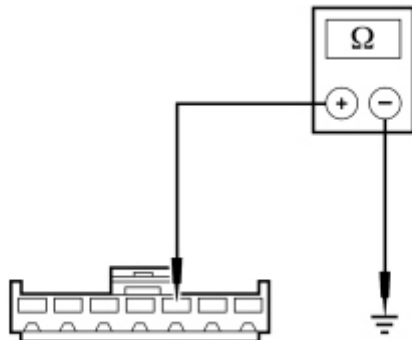

N0076773

- Is the resistance greater than 10,000 ohms?

INSTALL a new interior auto-dimming mirror. REFER to [Auto-Dimming Interior Mirror](#) in this section. CLEAR the DTCs. REPEAT the self-test.

No
GO to [D15](#).

D15 CHECK CIRCUIT 2016 (WH/LG) FOR A SHORT TO GROUND

- Ignition OFF.
- Disconnect: [SJB_C2280C](#).
- Measure the resistance between interior auto-dimming mirror C911-3, circuit 2016 (WH/LG), harness side and ground.

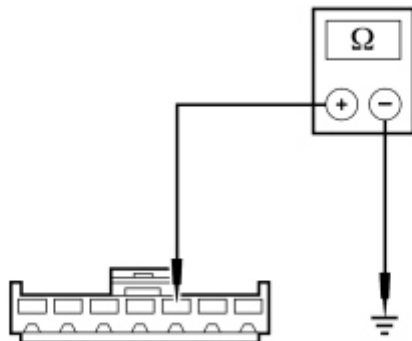

N0076773

- Is the resistance greater than 10,000 ohms?

Yes
GO to [D16](#).

No
REPAIR the circuit. CLEAR the DTCs. REPEAT the self-test.

D16 CHECK THE [SJB](#) FOR CORRECT OPERATION

- Disconnect all [SJB](#) connectors.
- Check for:
 - corrosion.
 - pushed-out pins.
- Connect all [SJB](#) connectors and make sure they seat correctly.
- Operate the system and verify the concern is still present.
- Is the concern still present?

Yes
INSTALL a new [SJB](#). REFER to [Section 419-10](#). CLEAR the DTCs. REPEAT the self-test.

No
The system is operating correctly at this time. Concern may have been caused by a loose or corroded connector. CLEAR the DTCs. REPEAT the self-test.

